

# Cast Iron Radiator

## BGL-600

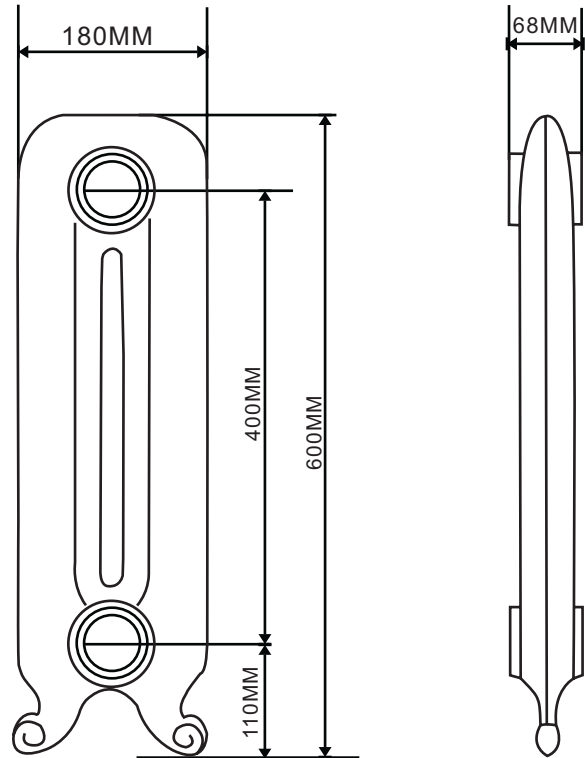

Specification	Weight	Delta 50	Delta 60
sections	kgs	watts	watts
3	27	255	318
4	36	340	424
5	45	425	530
6	54	510	636
7	63	595	742
8	72	680	848
9	81	765	954
10	90	850	1060
11	99	935	1166
12	108	1020	1272
13	117	1105	1378
14	126	1190	1484
15	135	1275	1590