

ASTRA G-18 MS/MES

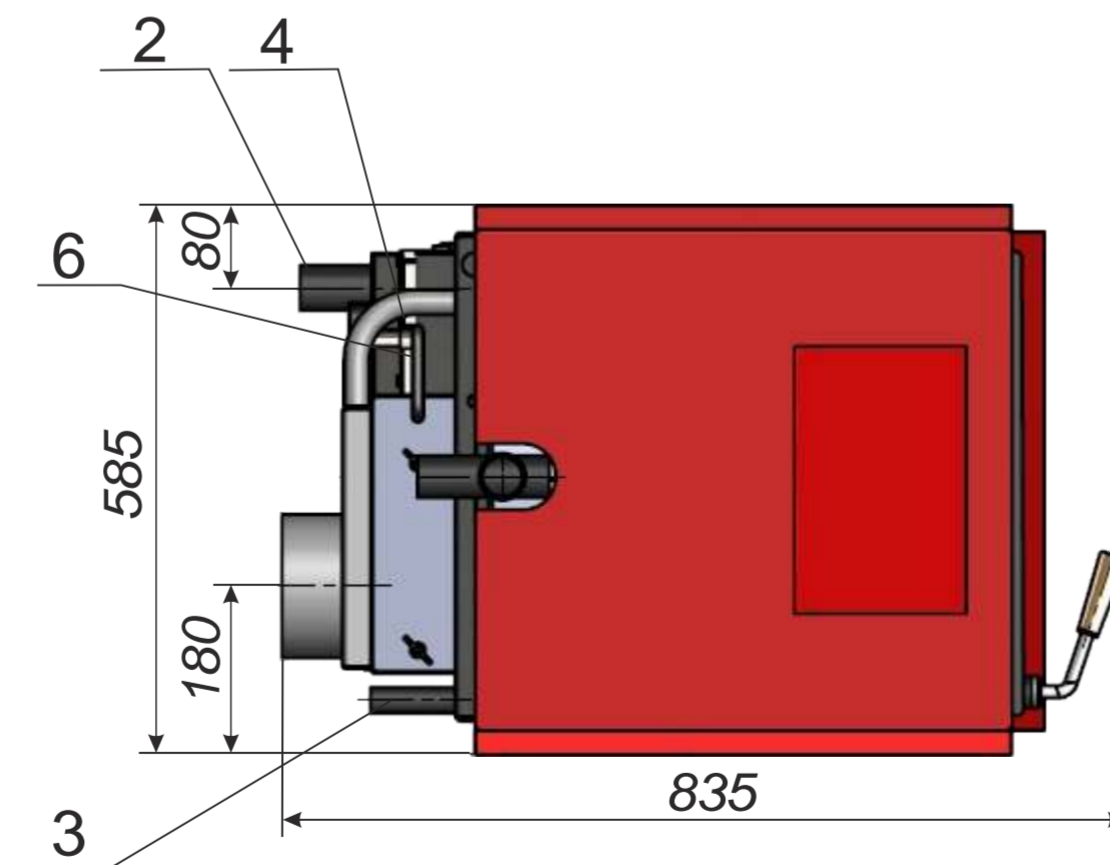
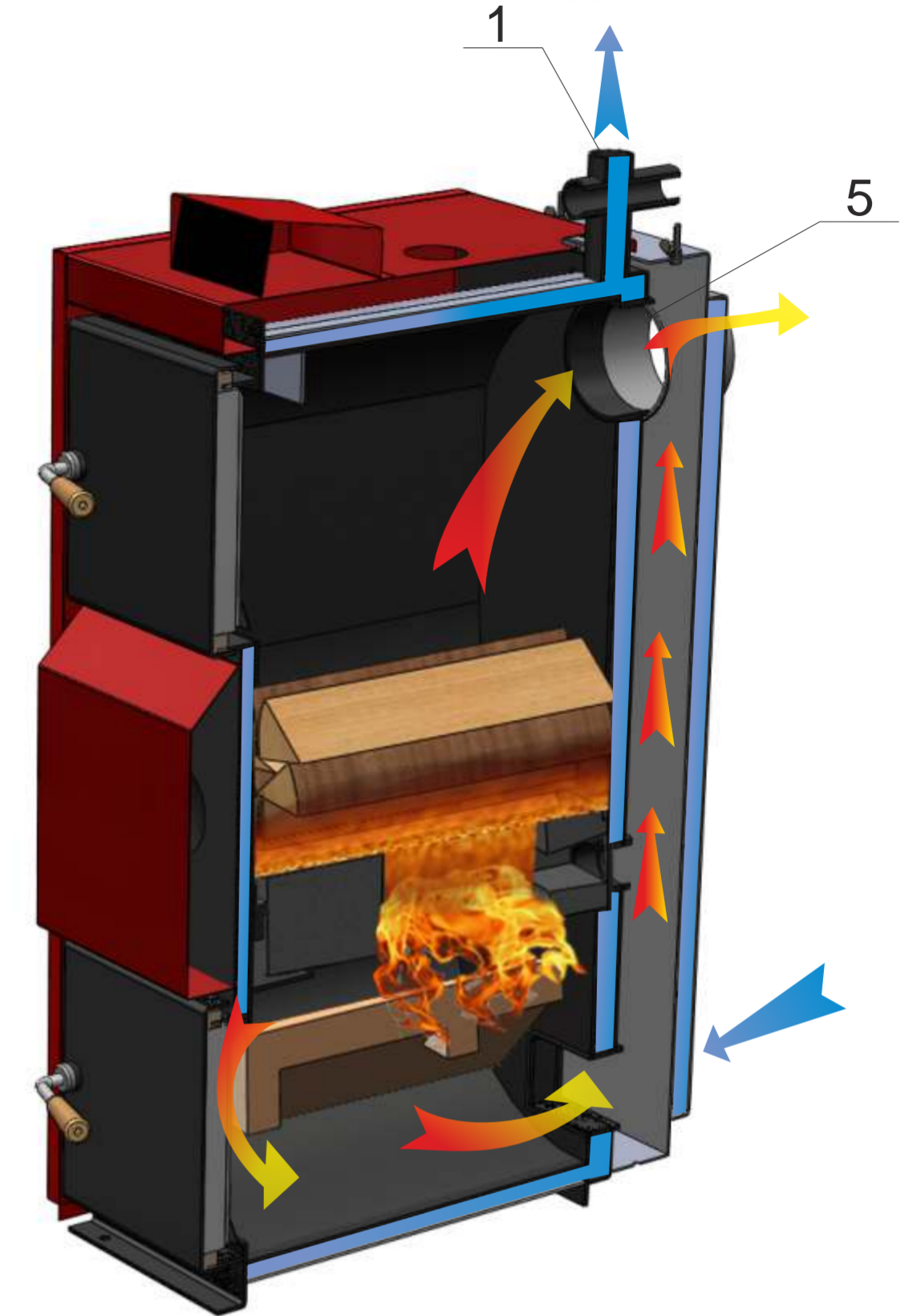
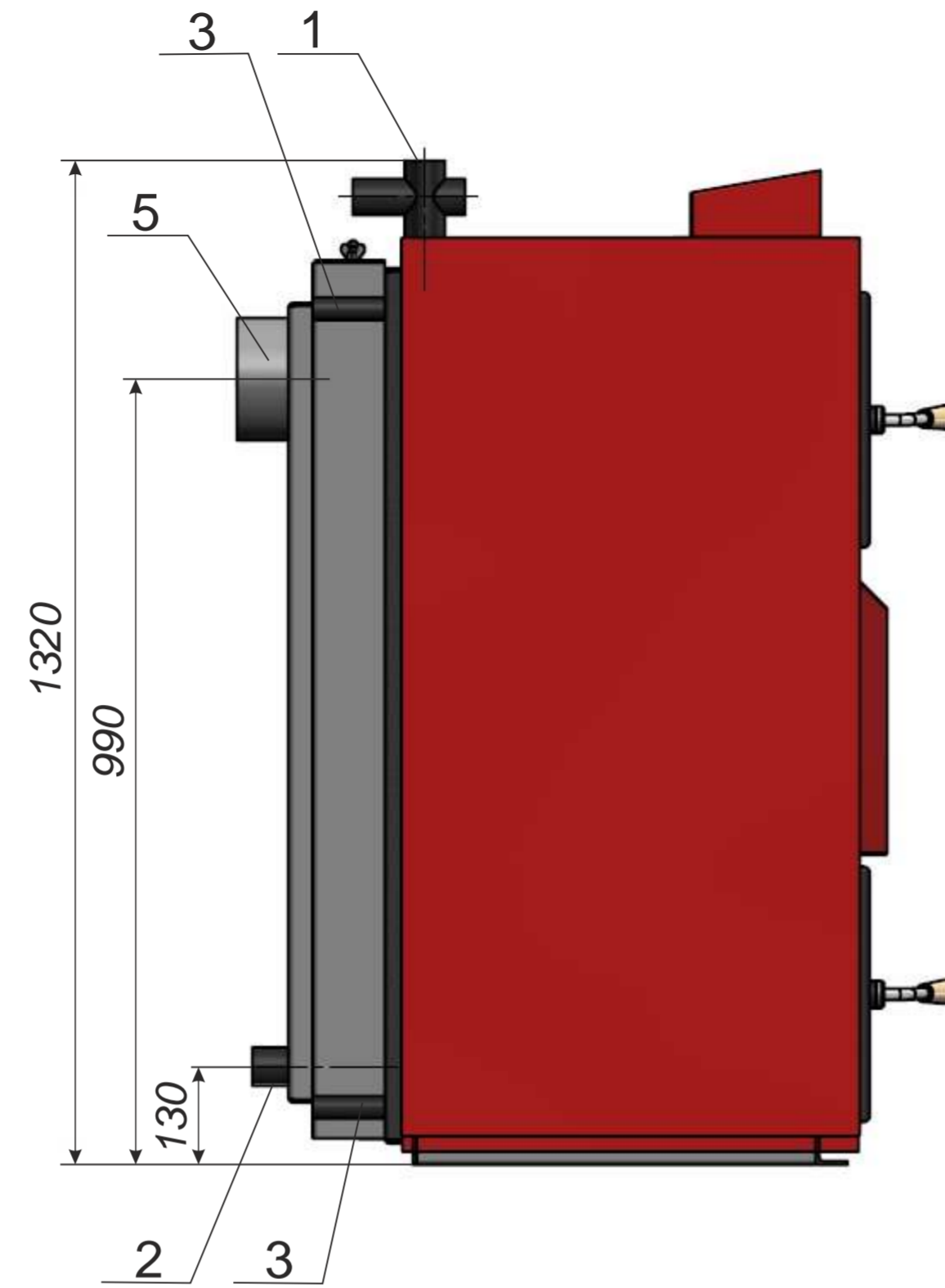

1. dens padeve G1 ½"
2. dens atpl de G1 ½"
3. Dzes šanas spir les piesl gums G ½"
4. dens izpl de G ½"
5. D m vads 6"
6. Ventilators
7. Vad bas pulsts
8. Gaisa aizb d a svira